



# Standard Test Method for Structural Performance of Glass in Windows, Curtain Walls, and Doors Under the Influence of Uniform Static Loads by Nondestructive Method<sup>1</sup>

This standard is issued under the fixed designation E998; the number immediately following the designation indicates the year of original adoption or, in the case of revision, the year of last revision. A number in parentheses indicates the year of last reapproval. A superscript epsilon ( $\epsilon$ ) indicates an editorial change since the last revision or reapproval.

## 1. Scope

1.1 This test method is a nondestructive test procedure to establish the nature of stresses induced in glass subjected to uniform static loads. A procedure is provided for using this stress information to estimate the probability of breakage of the glass.

1.2 This test method is applicable to glass of various degrees of temper; for example, annealed, heat-strengthened, fully tempered, laminated, insulating, and combinations thereof.

1.3 This test method describes a process of applying specific test loads to glass. The test may be conducted using the standard test frame specified herein or a test frame of the user's design.

1.4 The values stated in SI units are to be regarded as standard. The values given in parentheses are mathematical conversions to inch-pound units that are provided for information only and are not considered standard.

1.5 *This standard does not purport to address all of the safety problems, if any, associated with its use. It is the responsibility of the user of this standard to establish appropriate safety and health practices and determine the applicability of regulatory limitations prior to use.* For specific precautionary statements see Section 7.

## 2. Referenced Documents

- 2.1 *ASTM Standards*:<sup>2</sup>  
[E631 Terminology of Building Constructions](#)

## 3. Terminology

### 3.1 Definitions:

<sup>1</sup> This test method is under the jurisdiction of ASTM Committee E06 on Performance of Buildings and is the direct responsibility of Subcommittee E06.51 on Performance of Windows, Doors, Skylights and Curtain Walls.

Current edition approved April 1, 2012. Published May 2012. Originally approved in 1984. Last previous edition approved in 2011 as E998 – 11. DOI: 10.1520/E0998-12.

<sup>2</sup> For referenced ASTM standards, visit the ASTM website, [www.astm.org](http://www.astm.org), or contact ASTM Customer Service at [service@astm.org](mailto:service@astm.org). For *Annual Book of ASTM Standards* volume information, refer to the standard's Document Summary page on the ASTM website.

3.1.1 For definitions of general terms related to building construction used in this test method refer to Terminology E631.

### 3.2 Definitions of Terms Specific to This Standard:

3.2.1 *aspect ratio*—a ratio of long side to short side of the glass lite.

3.2.2 *average breaking stress (ABS)*—the average maximum principal tensile stress (MPTS) at failure, representative of the glass under test. The ABS is dependent on a number of factors including geometry, time history of load, surface condition, and so forth. Glasses with residual surface stresses, such as heat-strengthened or fully tempered, must have their residual stresses added to the state of stress at the specified load. As defined for use in the standard, the ABS is for annealed glass.

3.2.3 *coefficient of variation*—the ratio (decimal fraction) of the standard deviation of the maximum principal tensile stress (MPTS) at failure to the ABS.

3.2.4 *equivalent design load*—a magnitude of a uniform load and the load duration selected by the specifying authority to represent design loads.

3.2.5 *glass specimen*—the glass to be tested, for example, a single lite, an insulating glass unit, laminated glass, and so forth (does not include test frame).

3.2.6 *maximum principal tensile stress (MPTS)*—a maximum calculated tensile stress based on strain gage measurements.

3.2.7 *negative load*—a load that results in the indoor side of a glass specimen being the high-pressure side.

3.2.8 *permanent set of test frame*—a load-induced permanent displacement from an original position of the test frame.

3.2.9 *positive load*—a load that results in the outdoor side of a glass specimen being the high-pressure side.

3.2.10 *probability of breakage*—the probability that a glass specimen breaks when tested at a given equivalent design load. General industry practice to express probability as lites per 1000 lites.

3.2.11 *residual stress*—an initial, state of stress on unloaded, unglazed glass resulting from the manufacturing process (heat-strengthening, tempering).

3.2.12 *specifying authority*—the professional or professionals responsible for determining and furnishing the information required to perform this test method as described in Section 10.

#### 4. Summary of Test Method

4.1 This test method consists of:

4.1.1 Glazing the test specimen into a test frame that is mounted on or against a test chamber.

4.1.2 Supplying or exhausting air from the chamber at a rate required to maintain a test-pressure difference across the test specimen.

4.1.3 Measuring and observing deflections, deformations, specimen strains, and the nature of any failures.

4.1.4 Recording the results in an orderly manner.

4.2 Methods of loading to nondestructive levels are provided.

4.3 Test data are used to predict glass structural performance characteristics.

#### 5. Significance and Use

5.1 This test method is a standard procedure to determine a stress pattern and estimate a probability of breakage of glass tested under uniform static loads.

5.2 Loads on glass in windows, curtain walls, and doors may vary greatly in magnitude, direction, and duration. An understanding of wind loads on the building is required for selection of test loads and interpretation of results with respect to expected exposure at a particular site.

5.3 The strength of glass varies with many different factors including surface condition, load duration, geometry, relative humidity, and temperature (1, 2, 3, 4).<sup>3</sup>

5.4 A thorough understanding of the variations of the strength of glass and the nature of loading is required to interpret results of this test method.

5.5 The proper use of this test method requires a knowledge of the principles of pressure, deflection and strain measurement, stress/strain relationships, and statistical estimating techniques.

#### 6. Apparatus

6.1 The description of apparatus is general in nature. Any equipment capable of performing the test procedure within the allowable tolerances shall be permitted.

6.2 *Major Components:*

6.2.1 *Test Frame*, in which glass specimens are mounted for testing. The test frame shall provide either standardized support conditions or specified support conditions. Specifications of standardized support conditions are presented in Annex A1.

6.2.2 *Test Chamber*, sealed, with an opening in which or against which the test frame shall be installed. At least one static pressure tap shall be provided to measure the test chamber pressure and shall be so located that the reading is minimally affected by the velocity of the air supply to or from

<sup>3</sup> The boldface numbers in parentheses refer to the references listed at the end of this test method.

the test chamber or any other air movement. The air supply opening into the test chamber shall be arranged so that the air does not impinge directly on the glass specimen with any significant velocity. A means of access into the test chamber shall be permitted to facilitate adjustments and observations after the specimen has been installed.

6.2.3 *Air System*, a controllable blower, compressed air supply, exhaust system, reversible blower or other device designed to apply the equivalent design load to the glass specimen with required control.

6.2.4 *Pressure Measuring Apparatus*, to record continuously the test chamber pressure within an accuracy of  $\pm 2\%$ .

6.2.5 *Deflection-Measuring System*, for measuring deflections within an accuracy of  $\pm 0.25$  mm (0.01 in.).

6.2.5.1 The deflection indicator shall be mounted so that deflection of the test chamber or test frame is not included in the deflection gage reading. Provisions shall be made to ensure that readings can be made from a safe location.

6.2.6 *Strain Gage Measurements*—Appendix X1 describes apparatus and techniques required for proper strain measurements on glass.

6.2.7 *Temperature Measuring Apparatus*, to measure the ambient temperature within an accuracy of  $\pm 0.6^\circ\text{C}$  ( $1^\circ\text{F}$ ).

6.2.8 *Relative Humidity Measuring Apparatus*, to measure the relative humidity within an accuracy of  $\pm 2\%$ .

#### 7. Safety Precautions

7.1 Proper precautions to protect observers in the event of glass specimen failure shall be observed. At the pressures used in this test method, considerable energy and hazard are involved. In cases of breakage, the hazard to personnel is less with an exhaust system, as the specimen will tend to blow into rather than out of the test chamber. No personnel shall be permitted in such chambers during tests. All reasonable precautions shall be exercised during conduct of the test.

#### 8. Sampling and Glass Specimens

8.1 Surface condition, cutting, fabrication, and packaging of the glass specimens to be tested shall be representative of the glass whose strength is to be evaluated.

8.2 All glass specimens shall be visually inspected for edge or surface irregularities prior to testing, and all questionable glass specimens shall not be tested. All questionable glass specimens shall be reported to the specifying authority.

8.3 Glass specimens shall be handled carefully at all times because the strength of glass is influenced by its surface and edge conditions.

#### 9. Calibration

9.1 Pressure-measuring systems, deflection-measuring devices, and strain gages shall be routinely checked. If calibration is required, the manufacturer's recommendations or good engineering practice shall be followed.

#### 10. Required Information

10.1 The specifying authority shall provide the magnitude of the equivalent design load (positive or negative) and the allowable probability of breakage for the glass specimens.

10.2 The specifying authority shall state whether the glass specimens shall be glazed in a standard test frame or in a test frame designed to simulate a specific glazing system. If the test frame is to simulate a specific glazing system, complete glazing details and support conditions shall be provided by the specifying authority.

## 11. Procedure

11.1 Measure and record ambient temperature and the relative humidity.

11.2 Install strain gages to the low pressure side of the glass specimen according to procedures in [Annex A2](#).

11.3 Install glass specimens in the test frame in accordance with recommendations in [Annex A1](#) for standard support conditions or as specified for a specific glazing system by the manufacturer.

11.4 Record reference strain reading at no-load conditions.

11.5 Load specimen to low level pressure, 20 % of design load for 1 min. Release load. Allow 3 to 5-min gage and restoration time.

11.6 Apply one-half of the specified design load to the glass specimen. Take initial set of pressure, deflection, and strain readings at one-half of design load. Reduce the test pressure to 0, and vent the test chamber for a period of 3 to 5 min before pressure-measuring apparatus is adjusted to zero.

11.6.1 If air leakage around the test specimen is excessive, tape shall be permitted to be used to cover any cracks and joints through which the leakage is occurring. Tape shall not be used when there is a probability that it may significantly restrict differential movement between the glass and test frame.

11.7 Apply load to the glass specimen in increments of 20 % of specified design load, recording strain gage readings at each increment. Maintain the load at each increment of design load until all strain gage readings are taken. For each increment, the load should not be applied for a period under 1 min or longer than 5 min in duration. Continuous load-time records shall be kept for the duration of the loading.

11.8 If the specimen breaks prior to reaching the specified design load, check for permanent set of the test frame and chamber damage before testing another specimen.

## 12. Report

12.1 The report shall include the following information:

12.1.1 Date of the test, the date of the report, the ambient temperature, and the relative humidity.

12.1.2 Identification of the glass specimens (manufacturer, source of supply, dimensions, both nominal and measured, manufacturer's designation, materials, and other pertinent information).

12.1.3 Detailed drawings of the glass specimen, test frame, test chamber, a complete description of pressure-measuring apparatus, all other instrumentation, and a statement that the test was conducted using a standard test frame or a test frame of the user's design.

12.1.4 Records of pressure differences exerted across each glass specimen during the test with each specimen being properly identified.

12.1.5 Probability of breakage ( $Z_o$ ) as calculated in Section [13](#) (Analysis).

12.1.6 Identification or description of any applicable specification.

12.1.7 A statement that the tests were conducted in accordance with this test method, or a full description of any deviations.

## 13. Analysis

13.1 An analysis of the structural performance of the glass specimen(s) shall be made.

13.2 *Procedure A*:

13.2.1 Calculate maximum principal stress from strain gage data (see [Appendix X1](#)).

13.2.2 *Average Breaking Strength of Glass (ABS)*—The *ABS* is a necessary value for use in analyzing the structural performance of the glass. For new glass, the *ABS* shall be obtained from the appropriate glass manufacturer for the glass in question. For glass that has been in service, or treated by others (weathered, altered, damaged, scratched, or mechanically altered) engineering judgement shall be used to determine the *ABS*. The area of the glass lite and the duration of imposed load affect the *ABS*. The magnitude of the load duration effect can be roughly approximated by using [Eq X1.1](#) in [Appendix X1](#).

13.3 *Probability of Breakage*—Once glass *ABS* is established (Procedure A), the normal probability distribution function is used to predict probability of breakage. The probability of breakage for glass is calculated as follows:

$$\text{Area} = Pr(Z \geq z_o) \quad (1)$$

$$Z_o = \frac{X - ABS}{CV \times ABS}$$

where:

$X$  = maximum glass tension stress resulting from specified or test wind load, MPa (psi),

$ABS$  = glass *ABS*, MPa (psi),

$CV$  = coefficient of variation, 0.22 for annealed glass, and

$Z_o$  = standard normal variable (see [Table X1.2](#)).

Using the standard normal distribution table, the area to the right of the  $Z_o$  indicates the probability of breakage at that level (see [Table X1.2](#)).

**NOTE 1**—Glasses with residual surface stresses, such as heat-strengthened or fully tempered, shall have their residual stresses added to the state of stress at the specified load. For example, the state of stress of a heat-strengthened glass surface is 35 MPa (5000 psi) at design load, if the glass has a residual compressive stress on the surface of 24 MPa (−3500 psi), the resulting tensile stress component is 10 MPa (1500 psi) at design load.

**NOTE 2**—Load/stress relationships for large deflections in glass may be adequately defined by finite-element computer techniques. The values obtained by this technique will be useful for defining probability of breakage estimates at various load/glass stress combinations.

## 14. Precision and Bias

14.1 No statement is made about either the precision or the bias of this test method for measuring the structural performance of glass since the result merely states whether the probability of breakage of the glass specimens is significantly greater than the specified probability of breakage or not.

## 15. Keywords

15.1 annealed glass; curtain walls; doors; flat glass; fully tempered glass; glass performance; heat-strengthened glass; nondestructive testing; performance testing; strain gages; structural performance; uniform static loads; windows

## ANNEXES

### (Mandatory Information)

#### A1. STANDARD GLASS TEST FRAME

##### A1.1 Introduction

A1.1.1 The standard test frame shall be designed to support a rectangular glass specimen in a vertical plane and expose it to a positive (inward-acting) load. The test frame shall consist of two primary systems: a structural support system and a glazing system. The structural support system shall be designed to resist applied loads with limited deflections and provide an interface between the test chamber and the glazing system. The glazing system shall be designed to limit lateral displacements of the glass specimen edges while minimizing rotational and in-plane restraints of the glass specimen edges. This annex presents pertinent details relating to the design and construction of a standard test frame.

##### A1.2 Structural Support System

A1.2.1 The structural support system shall consist of four main structural members arranged as shown in Fig. A1.1. The inside rectangular dimensions,  $a$  and  $b$ , of the support system shall be found by subtracting 25 mm (1 in.) from the corresponding dimensions of the glass specimens. These dimensions shall be maintained within a tolerance of  $\pm 1.6$  mm ( $1/16$  in.).

A1.2.2 The structural members shall be selected from available American Standard channels with flange widths greater than or equal to 44 mm ( $1\frac{3}{4}$  in.). The structural members are to be designed to withstand the appropriate proof load without permanent deformations. In addition, the structural members shall be designed to meet the following deflection criteria:

A1.2.2.1 The maximum lateral deflection (referenced to glass specimen) of the structural members shall not exceed  $L/750$  where  $L$  is the length of the shorter side of the glass specimen,

A1.2.2.2 The maximum rotation of the structural members shall not exceed  $1^\circ$ , and

A1.2.2.3 The maximum in-plane deflection (referenced to the glass specimen) of the structural members shall not exceed  $L/2000$ .

A1.2.3 The corner connections of the support system shall be designed using angle braces and bolts to minimize racking or twisting during testing.

A1.2.4 In addition to the above criteria, the following fabrication tolerances shall be met:

A1.2.4.1 The maximum out-of-plane offset at the corners shall not exceed 0.4 mm ( $1/64$  in.) (see Fig. A1.1),

A1.2.4.2 The maximum planar variation of the outside edges of the structural members shall not exceed 1.6 mm ( $1/16$  in.).

A1.2.4.3 The maximum difference in the measured diagonals of the interior rectangular opening shall not exceed 3 mm ( $1/8$  in.), and

A1.2.4.4 The depth of the structural members shall be sufficient to allow unimpaired lateral displacements of the glass specimens during the test.

A1.2.5 Finally, holes shall be provided as required in the flanges of the structural members for fasteners used to retain the glass specimen.

##### A1.3 Glazing System

A1.3.1 The glazing system, which attaches to the vertical structural support system, shall consist of the following major components (see Fig. A1.2, Fig. A1.3 and Fig. A1.4):

A1.3.1.1 Inside and outside glazing stops,

A1.3.1.2 Aluminum spacers,

A1.3.1.3 Inside and outside neoprene gaskets,

A1.3.1.4 Structural fasteners, and

A1.3.1.5 Neoprene setting blocks.

A1.3.2 The glass specimen shall rest on two neoprene setting blocks ( $85 \pm 5$  shore A durometer) as shown in Fig. A1.4. The glass specimen shall be laterally supported around its perimeter with neoprene gaskets ( $65 \pm 5$  Shore A durometer). The glass specimen shall be centered within the glazing system to a tolerance of  $\pm 1.5$  mm ( $1/16$  in.). A minimal clamping force (700 to 1750 N/m (4 to 10 lbf/in.)) shall be applied to the edge of the glass specimen. The clamping force shall be determined for various glass thicknesses and shims by using a load cell or force gage in the glazing pocket when the wing bolts are firmly tightened.

A1.3.3 The glazing stops shall be fabricated using 13 by 76-mm ( $1/2$  by 3-in.) aluminum bar stock in sections no shorter than 610 mm (24 in.) or the smaller rectangular glass specimen dimension. A 3.2 by 9.5-mm ( $1/8$  by  $3/8$ -in.) rectangular slot shall be machined in the glazing stops as shown in Fig. A1.3. At each corner the glazing stops shall be mitered and fitted as shown in Fig. A1.2.



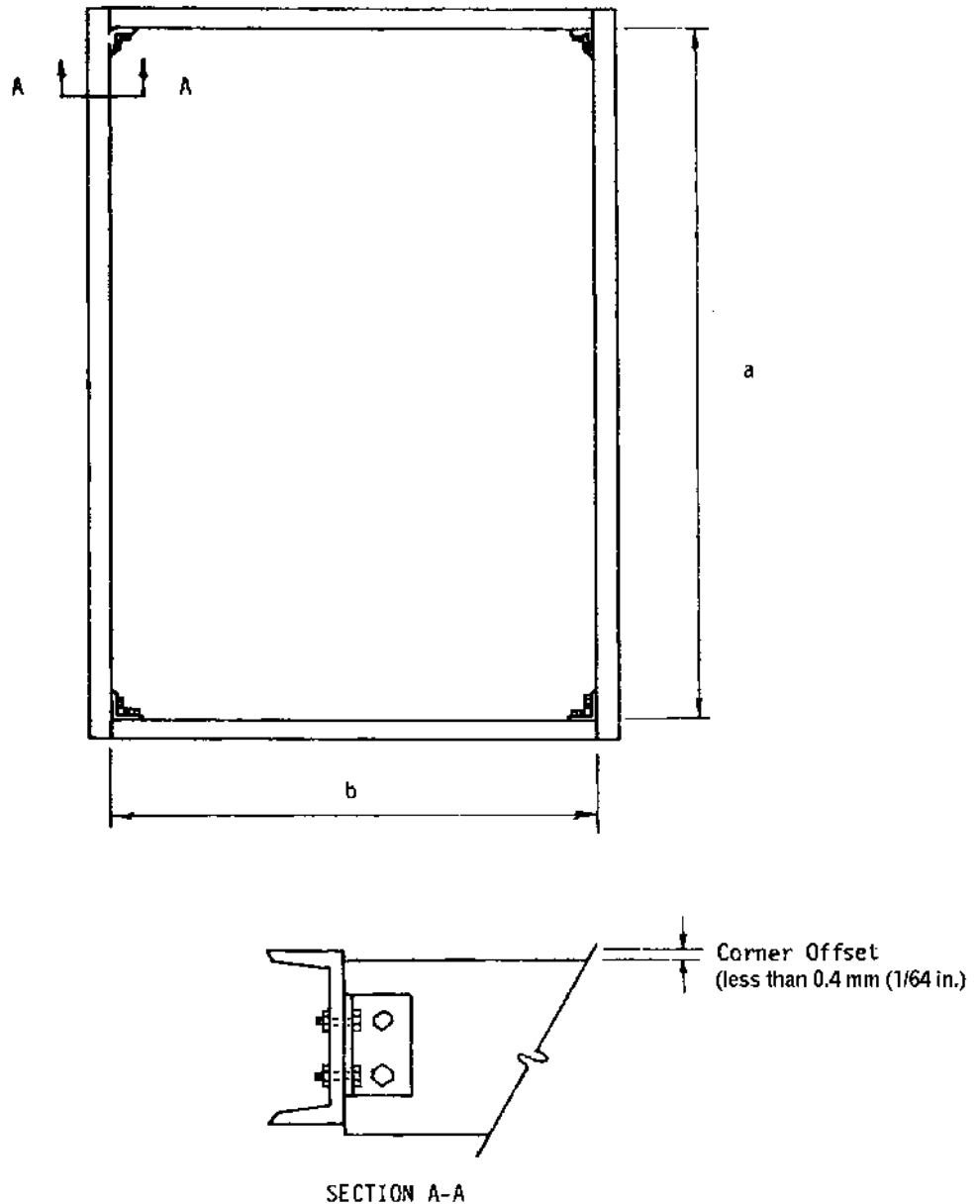

FIG. A1.1 Structural Support System

A1.3.4 The inside glazing stop shall be fastened to the top flange of the structural support members using 6.4-mm (1/4-in.) diameter bolts. These bolts shall pass through a clear hole in the channel flange into a threaded hole in the inside glazing stop. These bolts shall not extend above the surface of the inside glazing stop. These bolts shall be spaced no further than 610 mm (24 in.) apart with no fewer than two bolts per glazing stop section.

A1.3.5 The outside glazing stop shall be secured to the support system using 9.5-mm (3/8-in.) diameter wing bolts. These bolts shall pass through the outside glazing stop, through the aluminum spacer, and into a threaded hole in the support channels. In the corner areas there shall be three wing bolts spaced at 150-mm (6-in.) intervals as shown in Fig. A1.2.

Between these corner bolts, the bolts shall be spaced no further than 457 mm (18 in.) apart with a minimum of two bolts per glazing stop section.

A1.3.6 The rectangular aluminum spacers shall be fabricated using 19-mm (3/4-in.) wide aluminum bar stock. The width of the aluminum spacer shall be sufficient to extend from the outer edge of the Standard Glazing System frame at least 6 mm (1/2 in.) past the shaft of the wing bolt as shown in Fig. A1.3. Clearance holes shall be drilled into the aluminum spacer to allow the wing bolts to pass through. The thickness of the aluminum spacer shall be determined such that the glass edge pressure complies with the requirements of A1.3.2. The depth of the spacers shall be equal to the thickness of the glass plus 9.5 mm (3/8 in.). This dimension shall be maintained within a

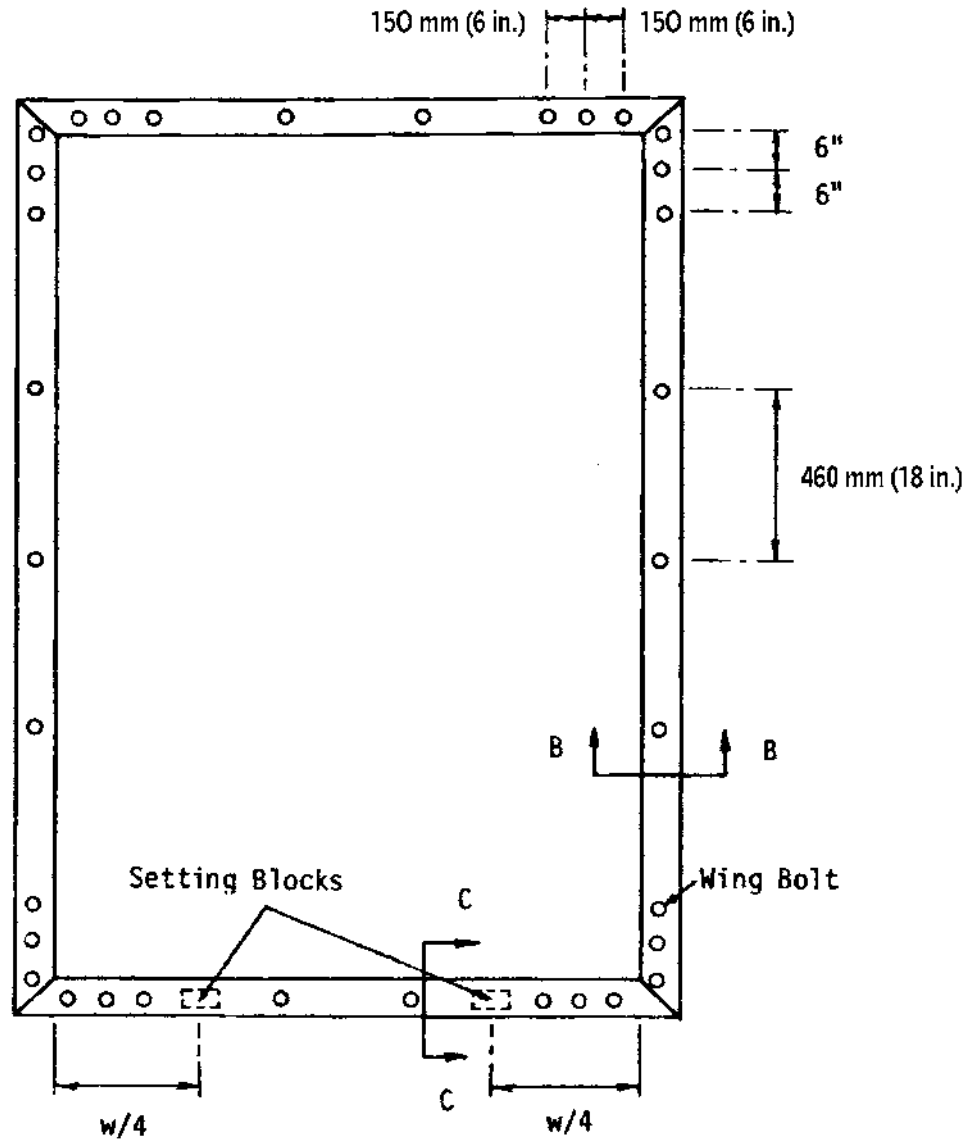

FIG. A1.2 Standard Glazing System

tolerance of  $\pm 0.8$  mm ( $1/32$  in.). The lengths of the spacers shall correspond to the lengths of matching outside glazing stop sections. In corner areas the spacers shall extend no further than 25.4 mm (1 in.) past the corner of the installed glass specimen. The spacers shall be fastened to the outside glazing stops using 6-mm ( $1/4$ -in.) diameter bolts. These bolts pass through the outside glazing stop into a threaded hole in the spacer. These bolts shall be spaced no further than 610 mm (24 in.) apart with no fewer than 2 bolts per glazing stop section.

A1.3.7 Two neoprene ( $85 \pm 5$  Shore A durometer) setting blocks shall be centered at the quarter points of the glass specimen as shown in Fig. A1.2. Appropriate supports, fastened through the inside glazing stop to the support channels, shall be provided. The required length of a setting block (in millimetres (inches)) shall be found by multiplying the glass specimen area (square metres) (square feet) by 0.10. However,

in no case shall the setting block length be less than 102 mm (4 in.). The width of the setting block shall be 1.6 mm ( $1/16$  in.) greater than the specimen thickness so that continuous support across the thickness of the specimen is provided.

A1.3.8 The neoprene gaskets shall be fabricated using 8.0-mm ( $5/16$ -in.) thick neoprene ( $65 \pm 5$  Shore A durometer) to fit snugly into the glazing stop slots. These gaskets shall be placed so that continuous support of the glass specimen perimeter is achieved. The gaskets shall be permitted to be held in place using an appropriate adhesive. However, the neoprene surface in contact with the glass specimen shall be kept free of all foreign materials.

A1.3.9 Silicone sealant or other appropriate material shall be used to seal joints against leakage. However, under no circumstances shall a sealant contact the glass specimen.

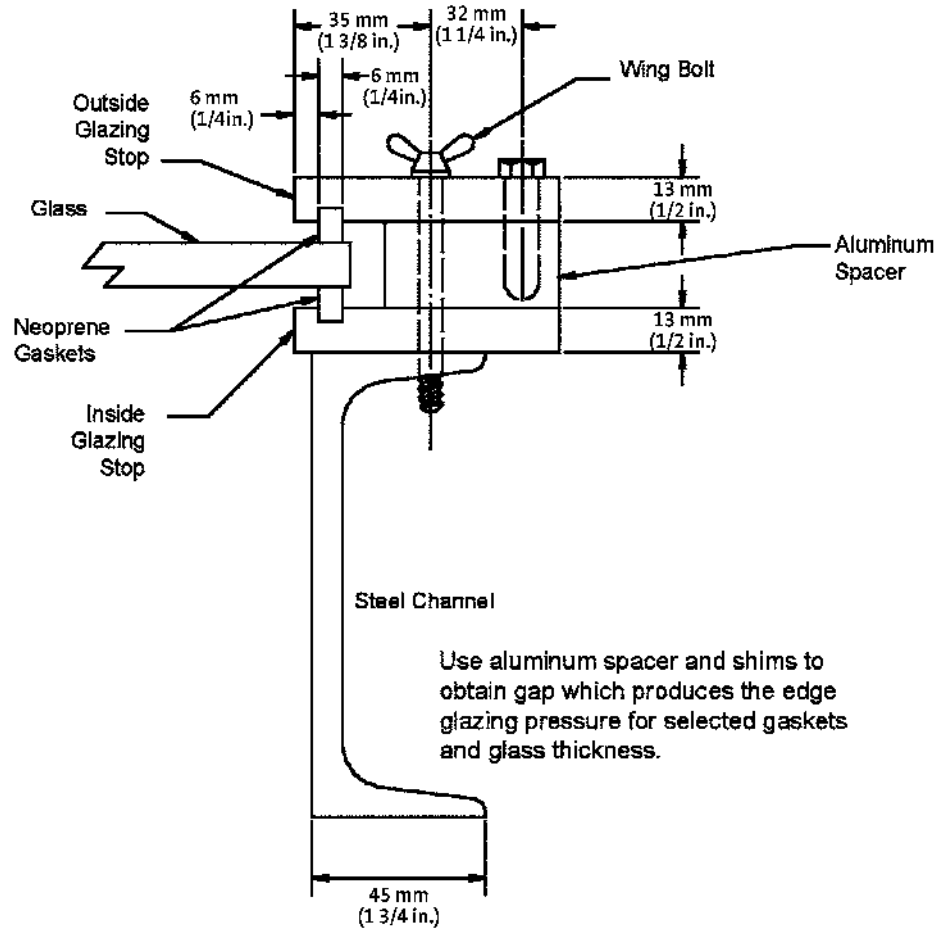

FIG. A1.3 Section B-B of Standard Glazing System

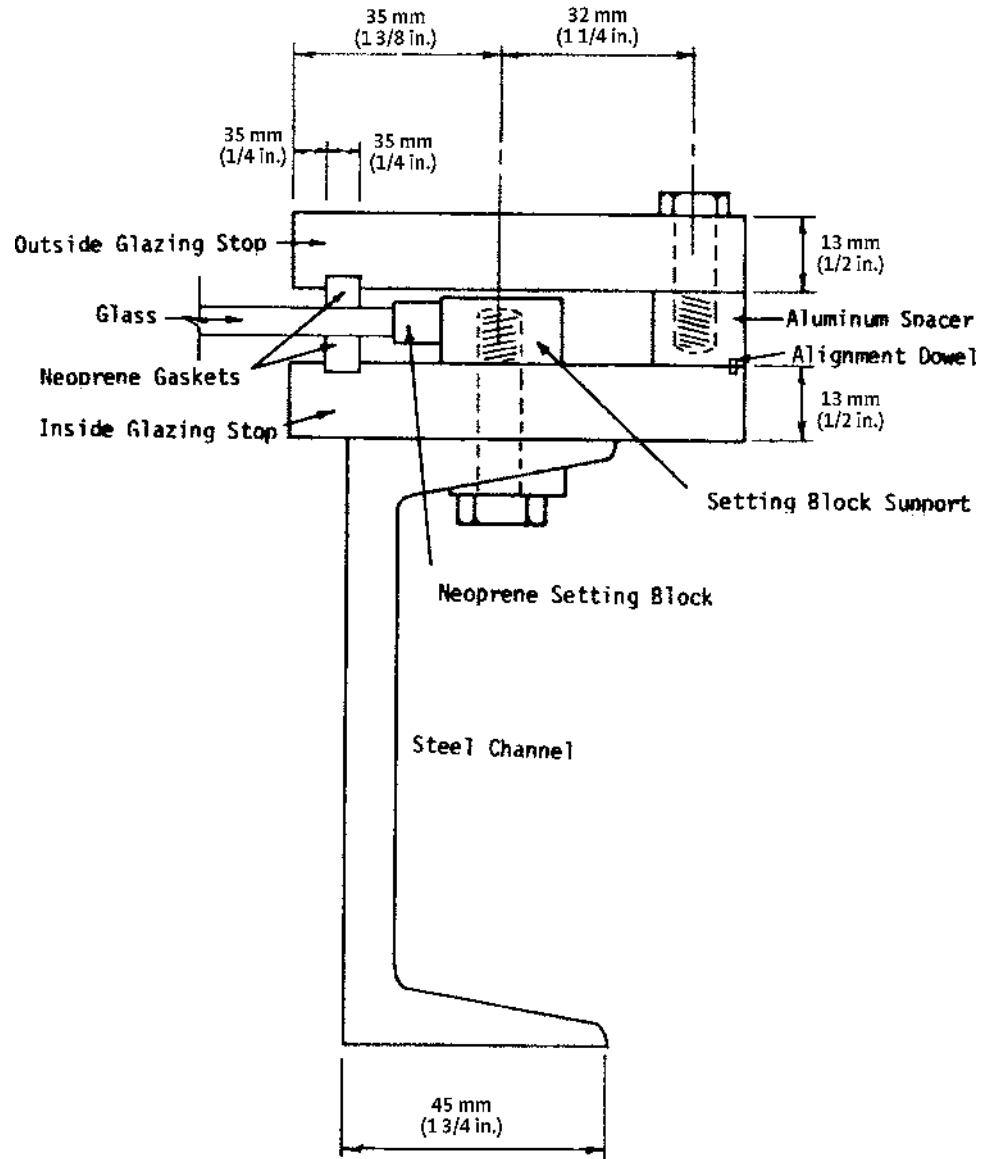

FIG. A1.4 Section C-C of Standard Glazing System

## A2. INSTALLATION OF STRAIN GAGES

### A2.1 Glass Surface Preparation Safeguards and Cleaning Recommendations

A2.1.1 *Glass Surface Preparation Safeguards*—The purpose of surface preparation is to develop a chemically clean surface appropriate to the strain-gage installation. Cleanliness is vital throughout the surface preparation process. It is important to guard against recontamination of a once-cleaned surface by:

A2.1.1.1 Never touching or placing dirty or contaminated objects on a clean area where strain gages are to be applied.

A2.1.1.2 Protecting the area where strain gages are to be applied from airborne contaminants in unclean areas if glazing is delayed by covering the cleaned area with plastic film.

A2.1.2 *Glass Cleaning Recommendations*—It is usually advisable to thoroughly clean the entire surface of a lite where strain gages are to be applied to avoid transfer of contaminants from an uncleaned adjacent area to the area where strain gages are to be applied. A variety of cleaning agents can be used for providing a chemically clean surface. A 1:1 solution of isopropyl alcohol and demineralized or distilled water applied



with clean, untreated cotton gauze, or paper towels has been found to be an effective final cleaning practice. For extremely dirty glass substrates, degreasing to remove oils, greases, organic contaminants, and chemical residues may be necessary. A variety of solvents and techniques are available for this cleaning operation. Caution and care shall be exercised in their selection and use to preclude bodily injury or harm and possible damage to coated glass substrates.

## A2.2 Strain Gage Lay-Out Lines Application

A2.2.1 Perform a general cleaning of the glass surface(s) where strain gages are to be applied in accordance with A2.1.2.

A2.2.2 Using India ink reservoir pens, overhead projection pens (both water soluble and permanent inks), or other similar markers, draw perpendicular crossing strain gage location layout lines on the glass surface at the specific location and orientation (direction of strain measurement) where the strain gages are to be placed.

NOTE A2.1—Layout lines are usually left on the substrate until the gage position and orientation are established. Gages are typically installed such that the longitudinal and transverse gage axes markings are aligned with the layout lines on the substrate. The line portions where the gages are bonded to the substrate shall be removed just prior to application of the bonding cement.

## A2.3 Strain Gage Installation Methods, Techniques, and Tips

A2.3.1 *Test Environment and Duration of Test*—The type of strain gage and bonding cement will in large part be predicated by the test environment and duration of test. If the test is to be performed in wet, rainy, high humidity or high temperature conditions, or combination thereof, or if the test exceeds several weeks in duration, the strain gage manufacturer shall be contacted for specific bonding cement recommendations.

### A2.3.2 Strain Gage Application:

NOTE A2.2—Strain gage application techniques should also be available from the strain-gage supplier.

A2.3.2.1 On a clean portion of the test lite, away from the gage locations, adhere 1 in. wide by 25 mm wide by 150 mm long (6 in. long) cellophane tape strips, one piece for each of the strain gages to be installed. If wrinkles, loops, or twists appear in any of the tape pieces, replace them. Fold the ends back, adhesive to adhesive, for about 6.4 mm (1/4 in.) to simplify lifting the tape in subsequent steps.

A2.3.2.2 Remove strain gages from the packaging material, handling strain gages individually with clean tweezers. Care shall be taken not to damage the gage by crimping, bending, or cutting by using tweezers with irregular contact surfaces.

A2.3.2.3 Pull back one end of one cellophane tape piece to near the central region.

A2.3.2.4 Orient the strain gage so that the gage axes correspond to the preferred orientation on the test lite layout lines, and center the strain gage on the tape prior to adhering to the cellophane tape. The strain gage grid and solder connections must be toward the tape adhesive. Repeat for all gages being installed.

A2.3.2.5 Re-adhere the tape and the gage to the glass lite, observing the precautions in A2.3.2.1. Repeat for all strain gages.

A2.3.2.6 Carefully and accurately mark strain gage axes on the cellophane tape using a magnifier, a straight-edge, and a marker used for plate layout. Fine lines are preferable and shall extend the length and width of the tape. Repeat for all strain gages.

A2.3.2.7 *Grasp* one piece of cellophane tape at both ends (to restrain curling, rolling, and twisting), and carefully lift the tape and gage from the glass lite.

A2.3.2.8 Superimpose cellophane tape gage axes lines over the glass lite layout lines at the desired location.

A2.3.2.9 Press the tape to the lite when lines are satisfactorily superimposed. Repeat for all strain gages.

A2.3.2.10 Grasp one end of tape and carefully lift at a shallow angle (approximately 30°) until the gage has been lifted from contact with the lite. Continue lifting the tape until it is free from the plate approximately 25 mm (1 in.) beyond the strain gage. The glass plate layout lines at the strain gage should be exposed.

A2.3.2.11 Pull the lifted end of the tape over the adhered end, exposing the strain gage and the tape mastic, and adhere the lifted end of the cellophane tape to the glass. This forms a loop in the tape with the mastic side up and the strain gage exposed.

A2.3.2.12 Using a clean cotton cloth or paper towel and a non-residue cleaning solvent, for example, 1:1 solution of isopropyl alcohol and distilled water, carefully and thoroughly clean area where the strain gage will bond to the glass lite, removing only the glass layout lines that are beneath and immediately adjacent to the strain gage site. The paper towel or cotton cloth used shall be clean, untreated, or free of soapy materials, or combination thereof.

A2.3.2.13 *Optional Steps*—(A2.3.2.13 and A2.3.2.14)—If a curing accelerator/catalyst is used with the methyl-2-cyanoacrylate adhesive, apply the curing accelerator to the bond surface of the gage. This is the exposed surface of the gage.

A2.3.2.14 Allow the catalyst to dry at least 1 min under conditions of 24°C (75°F), from 20 to 60 % relative humidity. Longer drying times are needed for lower temperatures or higher relative humidity.

NOTE A2.3—The next three steps are completed in rapid succession. Read all three steps before proceeding.

A2.3.2.15 Lift the end of the tape previously tucked under (see A2.3.2.11) and firmly re-adhere the tape to within about 6.4 mm (1/4 in.) of the gage, maintaining the tape in a gentle “pull-back” position. Apply 1 to 2 drops of methyl-2-cyanoacrylate adhesive at the junction of the tape and the plate.

A2.3.2.16 IMMEDIATELY, rotate the tape so that the gage bond surface is at an angle of about 5 to 30° to the plate, but bridging the installation area. While holding the tape taut at this angle and aligning the strain gage axes lines with the remainder of the plate layout lines, prepare to bond the gage by taking a small piece of clean cloth or towel to apply a slow, firm, single sweeping motion across the gage and the tape, keeping the alignment lines superimposed. Firm pressure

during this step assures a thin, uniform film and the closest proximity to plate surface necessary for accurate strain measurement.

A2.3.2.17 IMMEDIATELY after completion of the above application, apply either firm-thumb pressure or a firm rubbing motion directly over the gage area for a period of at least 1 min under conditions of 24°C (75°F), from 30 to 60 % relative humidity. If either temperature or humidity are below these values, several minutes of firm pressure or rubbing, or both, are advised. Repeat above steps for other gages to be applied.

A2.3.2.18 After the gage has been bonded 5 min or longer, the tape may be removed by pulling it directly back over itself (at a 180° angle) with a slow, steady motion. The gage should remain bonded to the plate. Do not remove the tape until ready to attach lead wires.

A2.3.2.19 Residual adhesive surrounding the gage shall be removed from the glass using a razor blade at an acute angle. Care must be exercised not to damage the glass surface. Adhesive removal shall be made with the razor blade directed away from the strain gage. Residual adhesive is required to be removed so that moisture does not get under the gage and cause it to lift by using the adhesive as a “wick.”

A2.3.2.20 Apply a piece of masking tape over open-faced (unencapsulated) gage-grids to prevent damage during subsequent steps. This step is unnecessary when encapsulated gages are used.

A2.3.2.21 Burnish solder tabs with a standard pencil eraser if pre-soldered tabs are not on the strain gages.

A2.3.2.22 Apply a small amount of high quality solder flux to the solder tabs and with an appropriately sized soldering iron using an appropriate power level.

A2.3.2.23 Observing wiring suggestions by the strain gage manufacturer, attach lead wires (24–30 gage stranded) to the solder tabs. A quarter-bridge three-wire independent-circuit wiring arrangement functions very well. In this three-wire system, two of the leads shall be joined at the strain gage end but are maintained separately at the instrument end.

A2.3.2.24 Tape the lead wires to the plate, providing wire strain-relief loops near the strain gage to reduce accidental gage removal, should the wire be pulled or tugged.

A2.3.2.25 Seal the gage to the plate with the appropriate sealer, for example, air-dried polyurethane. As noted earlier, since methyl-2-cyanoacrylate cement is water soluble and hygroscopic, strain gage adhesion loss can occur in moist or high humidity conditions without use of a sealer. Several coats shall be permitted to be applied with ample drying time.

NOTE A2.4—Other types of adhesives are available which are less sensitive to environmental conditions, but which require a different set of cure conditions. Contact your strain-gage supplier for details.

## APPENDIX

### (Nonmandatory Information)

#### X1. STRAIN GAGE TECHNIQUES FOR ANALYSIS OF GLASS LITES

##### X1.1 Introduction

X1.1.1 When properly used, strain gages provide useful (structural) data for architects, designers, engineers, and code authorities. The purpose of this appendix is to describe apparatus and techniques and to analyze material for determination of glass stresses during load testing.

##### X1.2 Apparatus

X1.2.1 The apparatus selection is largely based upon a desire for portability, number of gage-monitoring locations, type of load, and budget considerations. The following apparatus are recommended:

###### X1.2.1.1 Measuring Equipment:

###### (1) Manual:

(a) Indicator, portable strain, wheatstone bridge-type.

(b) Switching/Balance Box, 10 channel, minimum

###### (2) Automatic:

(a) Analog-Digital Converter.

(b) Mini-Computer, with 16K memory.

###### X1.2.1.2 Gages, foil-type:

(1) Rosette, two-element.

(2) Rosette, three-element.

###### X1.2.1.3 Wire, No. 26-3 Conductor.

X1.2.1.4 *Gage Adhesives*, Eastman 910 (or equivalent) with catalyst.

###### X1.2.1.5 *Surface Preparation Material:*

- (1) *Conditioner and Neutralizer*, MNS-1 and MNA-1, or
- (2) *Isopropyl Alcohol and Distilled Water*, 50:50 solution.

X1.2.1.6 *Gage-waterproofing* (Gagekote or equivalent).

###### X1.2.1.7 *Miscellaneous:*

- (1) *Cellophane Tape*, 25 mm (1 in.),
- (2) *Masking Tape*, 25 mm (1 in.),
- (3) *Pencil Eraser*,
- (4) *Solder and Iron*.
- (5) *Glass Sample*, for dummy-gage mount.
- (6) *Glass-Handling Equipment*.

##### X1.3 Stress Distribution

X1.3.1 Maximum stresses and stress distribution are of primary interest. For lites of glass, glazed with two-, three-, or four-sided support, stress values are largely dependent on glass size, thickness, aspect ratio, nature of the load and support member performance. Maximum stress locations on plates with four-sided support can be approximated with the aid of **Fig. X1.1** so that strain gage placement can be properly positioned.

**TABLE X1.1 Data Obtained from a Three-Gage Rectangular Rosette**

	Gage No.	Zero or Reference Reading, $\mu\text{in.}/\text{in.}$ (a)	Microstrain Reading at 50 lbf/ft <sup>2</sup> (2395 Pa) (b)	Measured Strain (a - b), $\mu\text{in.}/\text{in.}$
First test	1 ( $\epsilon_1$ )	6 565	6 925	360
	2 ( $\epsilon_2$ )	5 480	5 955	475
	3 ( $\epsilon_3$ )	7 100	7 475	375
Second test	1 ( $\epsilon_1$ )	6 565	6 965	400
	2 ( $\epsilon_2$ )	5 480	6 030	550
	3 ( $\epsilon_3$ )	7 100	7 525	425
Average of tests	1 ( $\epsilon_1$ )	6 565	6 945	380
	2 ( $\epsilon_2$ )	5 480	5 993	513
	3 ( $\epsilon_3$ )	7 100	7 500	400

X1.3.2 While insufficient for stress profile construction, **Fig. X1.2** illustrates a minimum location of strain gages and dial indicators for various plate aspect ratios and thicknesses in accordance with where maximum stress is predicted as shown in **Fig. X1.1**. All gages shown are two-element rosettes except as indicated in **Fig. X1.2**. Gage orientations shall be parallel and perpendicular to lines of symmetry and the 45° diagonal. Note that good engineering practice always places gages at the test plate center location. Symmetrical support and uniform loading will usually allow investigators to monitor only one fourth (quadrants) of rectangular plates, since stress distributions are assumed to be symmetrical.

#### X1.4 Stress Data Calculations

X1.4.1 Determine strain for each gage, corrected readings for temperature and zero references.

X1.4.2 Calculate stresses using strain values recorded and formulas shown in **Table X1.3**. Note that only the gage-site stress along the gage axes is determined using two-element gages. Principal stresses, maximum and minimum, may be calculated for two-element gages only when principal stress axes and gage axes are coincident. If the principal stress axes are not coincident with the gage axes, maximum and minimum stresses on the plate can only be calculated using three or more properly arranged gages.

X1.4.3 For calculations, values are recommended as follows:

$$E = 72395 \text{ MPa} (10.5 \times 10^6 \text{ psi})$$

where:

$E$  = Young's modulus for glass.

$\mu$  = 0.22

where:

$\mu$  = Poisson's ratio for glass.

$\epsilon_1$ ,  $\epsilon_2$ , and  $\epsilon_3$  = strain measured by gages, subscripts refer to gage numbers shown in **Table X1.3**.

X1.4.4 For example, at a 535 N (120-lbf) test load, the data in **Table X1.4** using a two-element strain gage located at the center of a glass lite.

X1.4.5 Using two-gage maximum/minimum stress formulas, in accordance with **Table X1.3**, the stress calculations are as follows:

Maximum stress calculation,  $\sigma_{\max}$

$$\begin{aligned} &= \frac{E}{(1 - \mu^2)} (\epsilon_1 + \mu \epsilon_2) \\ &= \frac{10.5 \times 10^6}{(1 - 0.22^2)} (260 \times 10^{-6} - 0.22 \times 795 \times 10^{-6}) \\ &= 939 \text{ psi} (6.5 \text{ MPa}) \end{aligned}$$

Minimum stress calculation,  $\sigma_{\min}$

$$\begin{aligned} &= \frac{E}{(1 - \mu^2)} (\epsilon_2 + \mu \epsilon_1) \\ &= \frac{10.5 \times 10^6}{(1 - 0.22^2)} (-795 \times 10^{-6} + 0.22 \times 0.260 \times 10^{-6}) \\ &= -56.1 \text{ MPa} (-8141 \text{ psi}) \end{aligned}$$

X1.4.6 Because both  $\sigma_{\max}$  and  $\sigma_{\min}$  calculations were performed, the maximum stress was determined. It is good engineering practice to perform both  $\sigma_{\max}$  and  $\sigma_{\min}$  calculations.

X1.4.7 Test data in **Table X1.1** was obtained from a three-gage rectangular rosette.

X1.4.8 Using the formula for a three-gage rectangular rosette in **Table X1.3**, results are obtained as follows:

$$\begin{aligned} \text{Max} &= \frac{E}{2} \left\{ \frac{\epsilon_1 + \epsilon_3}{1 - \mu} + \frac{1}{1 + \mu} \sqrt{(\epsilon_1 - \epsilon_3)^2 + [2\epsilon_2 - (\epsilon_1 + \epsilon_3)]^2} \right\} \\ \text{Min} &= \frac{E}{2} \left\{ \frac{\epsilon_1 + \epsilon_3}{1 - \mu} - \frac{1}{1 + \mu} \sqrt{(\epsilon_1 - \epsilon_3)^2 + [2\epsilon_2 - (\epsilon_1 + \epsilon_3)]^2} \right\} \\ &= 44.2 \text{ MPa} (6415 \text{ psi}) \end{aligned}$$

$$\phi_p = 1/2 \text{ TAN}^{-1} \frac{Z\epsilon_2 - (\epsilon_1 + \epsilon_2)}{1 - \epsilon_3} = 47^\circ$$

X1.4.9 Again, the necessity for performing both calculations is illustrated. It is important to note that the principal maximum stress axis is located 47° from gage one axis in a direction the same as the gage numbering. Two-gage rosette calculations performed from the same data produce maximum/minimum stress values different from those above because the gage axes and principal stress axes are not coincident. For this particular example, two axis rosette stresses are: 5162 versus 4085 and 5334 versus 6415. For example, using  $\epsilon_1$  and  $\epsilon_3$  data and the two-gage stress formulas in **Table X1.3**  $\sigma_{\max} = 35.5$  MPa (5149 psi) and  $\sigma_{\min} = 36.7$  MPa (5324 psi). Both these values are substantially different from values obtained from the three-gage rectangular rosette method. To determine the influence of load duration, calculate as follows:

$$L = ABS(t_1) = ABS(t_0)(t_0/t_1)^{1/16} \quad (\text{X1.1})$$

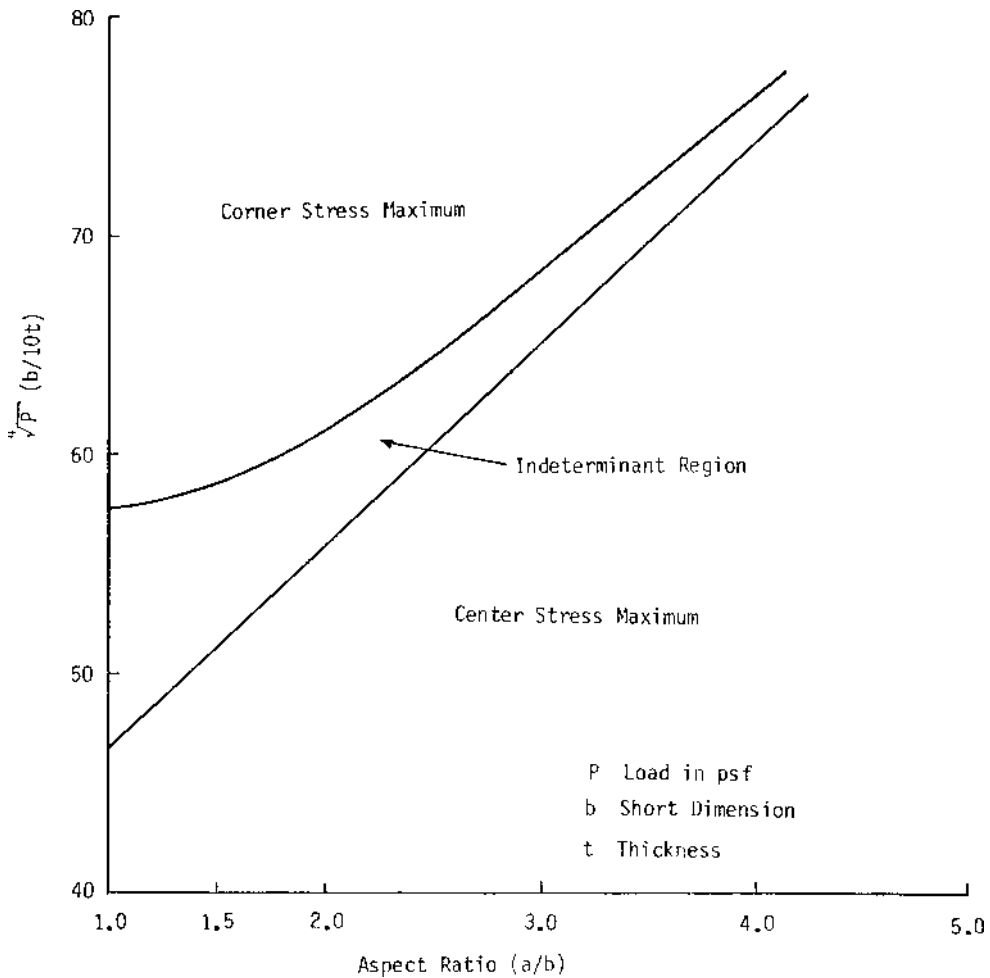

FIG. X1.1 Approximate Criterion for Determining Maximum Stress Location Simply Supported, Uniformly Loaded Lites

where:

$L$  = load duration,

$t_1$  = specified load duration, s and

$t_0$  = reference load duration for which ABS is known.

$$ABS(t_1) = 6000 (60/3)^{1/16}$$

$$ABS(t_1) = 50.5 \text{ MPa (7325 psi)}$$

For example, if the ABS of annealed glass is 41.3 MPa (6000 psi) at a load time of 60 s, a recommended ABS for a load duration of 3 s would be 7325 psi (50.5 MPa).

**TABLE X1.2 Probabilities That Given Standard Normal Variables Will be Exceeded<sup>A</sup>**

NOTE 1—The probabilities shown are for the upper-tail.

NOTE 2—The digits heading the columns are additional digits for the values of the normal variable shown in the first column. Thus, the probability corresponding with the standard normal variable 1.32 is found in the row in which “1.3” appears at the left and the column in which “2” appears at the top. The probability is 0.0934.

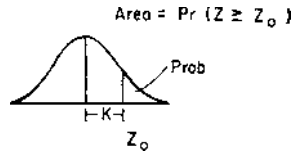

Normal $Z_0$ Variable	0	1	2	3	4	5	6	7	8	9
0.0	0.5000	0.4960	0.4920	0.4880	0.4840	0.4801	0.4761	0.4721	0.4681	0.4641
0.1	0.4602	0.4562	0.4522	0.4483	0.4443	0.4404	0.4364	0.4325	0.4286	0.4247
0.2	0.4207	0.4168	0.4129	0.4090	0.4052	0.4013	0.3974	0.3936	0.3897	0.3859
0.3	0.3821	0.3783	0.3745	0.3707	0.3669	0.3632	0.3594	0.3557	0.3520	0.3483
0.4	0.3446	0.3409	0.3372	0.3336	0.3300	0.3264	0.3228	0.3192	0.3156	0.3121
0.5	0.3085	0.3050	0.3015	0.2981	0.2946	0.2912	0.2877	0.2843	0.2810	0.2776
0.6	0.2743	0.2709	0.2676	0.2643	0.2611	0.2578	0.2546	0.2514	0.2483	0.2451
0.7	0.2420	0.2389	0.2358	0.2327	0.2296	0.2266	0.2236	0.2206	0.2177	0.2148
0.8	0.2119	0.2090	0.2061	0.2033	0.2005	0.1977	0.1949	0.1922	0.1894	0.1867
0.9	0.1841	0.1814	0.1788	0.1762	0.1736	0.1711	0.1685	0.1660	0.1635	0.1611
1.0	0.1587	0.1562	0.1539	0.1515	0.1492	0.1469	0.1446	0.1423	0.1401	0.1379
1.1	0.1357	0.1335	0.1314	0.1292	0.1271	0.1251	0.1230	0.1210	0.1190	0.1170
1.2	0.1151	0.1131	0.1112	0.1093	0.1075	0.1056	0.1038	0.1020	0.1003	0.0985
1.3	0.0968	0.0951	0.0934	0.0918	0.0901	0.0885	0.0869	0.0853	0.0838	0.0823
1.4	0.0808	0.0793	0.0778	0.0764	0.0749	0.0735	0.0721	0.0708	0.0694	0.0681
1.5	0.0668	0.0655	0.0643	0.0630	0.0618	0.0606	0.0594	0.0582	0.0571	0.0559
1.6	0.0548	0.0537	0.0526	0.0516	0.0505	0.0495	0.0485	0.0475	0.0465	0.0455
1.7	0.0446	0.0436	0.0427	0.0418	0.0409	0.0401	0.0392	0.0384	0.0375	0.0367
1.8	0.0359	0.0351	0.0344	0.0336	0.0329	0.0322	0.0314	0.0307	0.0301	0.0294
1.9	0.0287	0.0281	0.0274	0.0268	0.0262	0.0256	0.0250	0.0244	0.0239	0.0233
2.0	0.0228	0.0222	0.0217	0.0212	0.0207	0.0202	0.0197	0.0192	0.0188	0.0183
2.1	0.0179	0.0174	0.0170	0.0166	0.0162	0.0158	0.0154	0.0150	0.0146	0.0143
2.2	0.0139	0.0136	0.0132	0.0129	0.0125	0.0122	0.0119	0.0116	0.0113	0.0110
2.3	0.0107	0.0104	0.0102	0.0099	0.0096	0.0094	0.0091	0.0089	0.0087	0.0084
2.4	0.0082	0.0080	0.0078	0.0075	0.0073	0.0071	0.0069	0.0068	0.0066	0.0064
2.5	0.0062	0.0060	0.0059	0.0057	0.0055	0.0054	0.0052	0.0051	0.0049	0.0048
2.6	0.0047	0.0045	0.0044	0.0043	0.0041	0.0040	0.0039	0.0038	0.0037	0.0036
2.7	0.0035	0.0034	0.0033	0.0032	0.0031	0.0030	0.0029	0.0028	0.0027	0.0026
2.8	0.0026	0.0025	0.0024	0.0023	0.0023	0.0022	0.0021	0.0021	0.0020	0.0019
2.9	0.0019	0.0018	0.0018	0.0017	0.0016	0.0016	0.0015	0.0015	0.0014	0.0014
3.0	0.0013	0.0013	0.0013	0.0012	0.0012	0.0011	0.0011	0.0011	0.0010	0.0010

<sup>A</sup> Wallis, W.A., and Roberts, H.V., *Statistics: A New Approach*, The Free Press, 1956, p. 365.

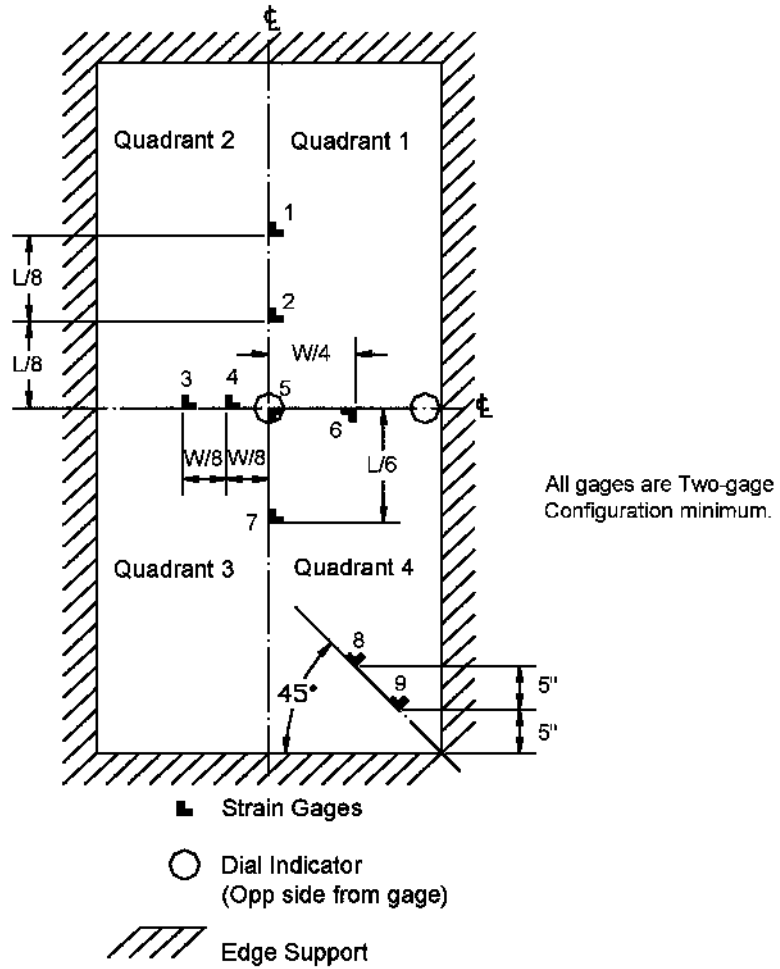

FIG. X1.2 Strain Gage and Dial Indicator Installation Locations for Four-Sided Support



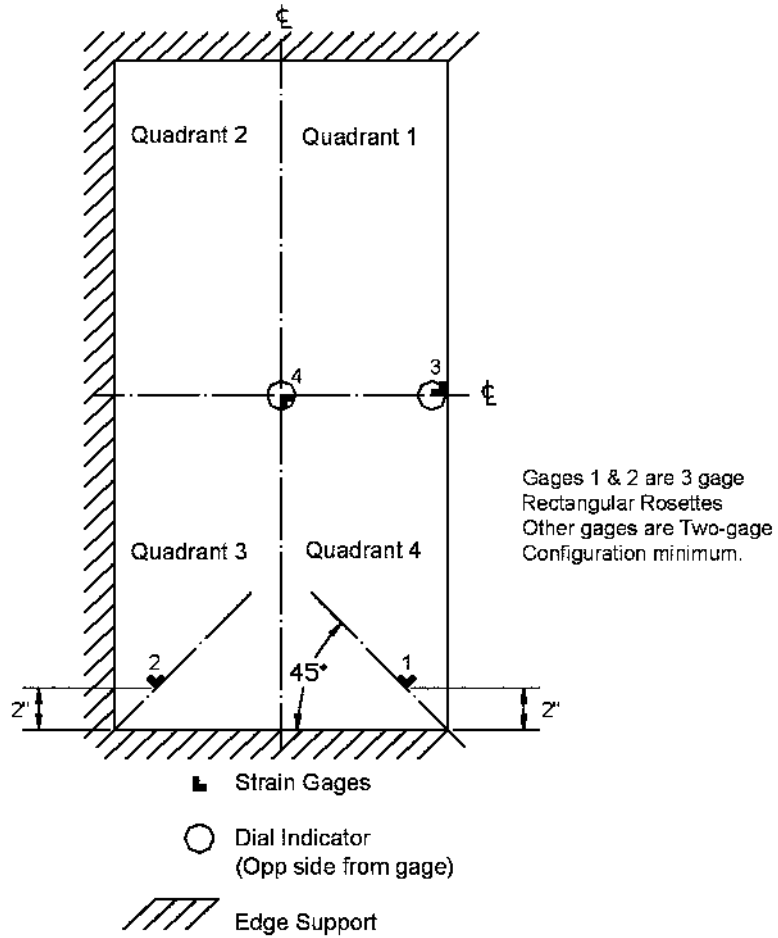
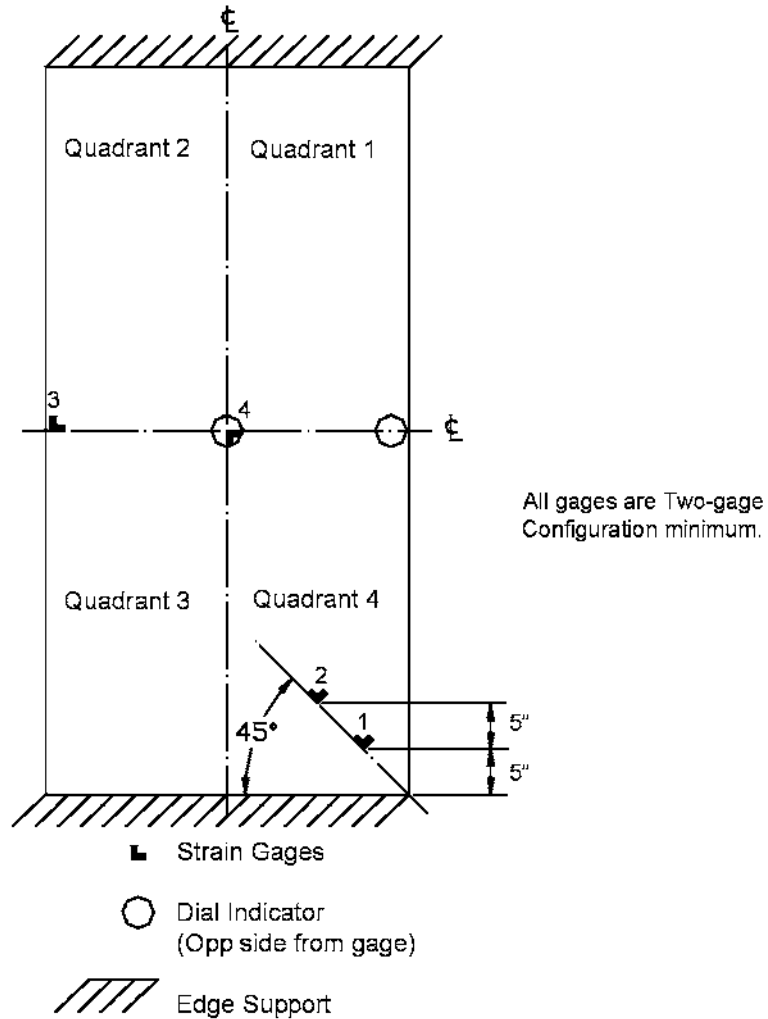

FIG. X1.3 Strain Gage and Dial Indicator Installation Locations for Three-Sided Support



NOTE 1—If maximum stress is in the indeterminant region, locate gages 1, 2, 3, and 5 as illustrated in quadrant 2 and gage 4 as illustrated in quadrant 4.

NOTE 2—For maximum stress in corner in accordance with Fig. X1.1, use quadrant 4, gage locations 1 through 5.

NOTE 3—For maximum stress in center in accordance with Fig. X1.1, use quadrant 2, gage locations 1 through 5.

NOTE 4—Strain gages shall be applied to the low pressure side of the glass.

**FIG. X1.4 Strain Gage and Dial Indicator Installation Locations for Two-Sided Support**

TABLE X1.3 Relations Between Strain Rosette Readings and Principal Stresses<sup>4</sup>

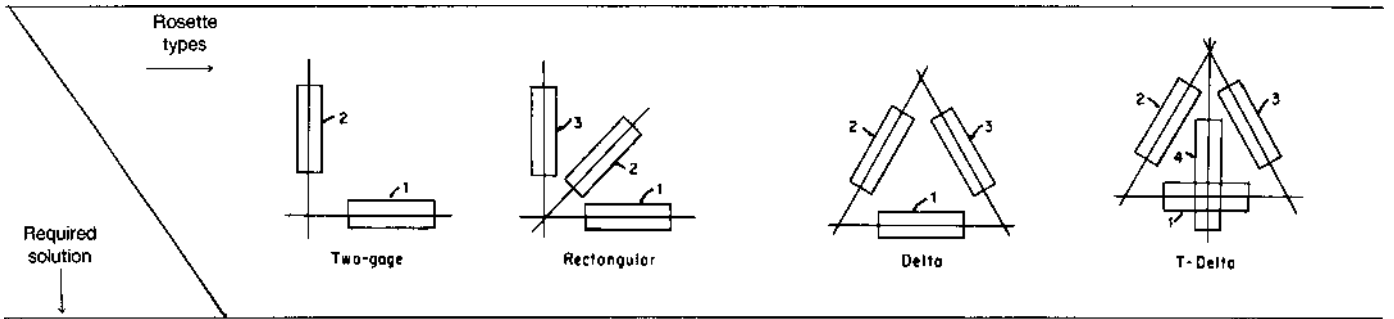

Maximum normal stress, $\sigma_{max}$	$\frac{E}{1-\mu^2} (\epsilon_1 + \mu \epsilon_2)$	$\frac{E}{2} \left\{ \frac{\epsilon_1 + \epsilon_3}{1-\mu} + \frac{1}{1+\mu} \right\}$	$E \left[ \frac{\epsilon_1 + \epsilon_2 + \epsilon_3}{3(1-\mu)} + \frac{1}{1+\mu} \right]$	$\frac{E}{2} \left[ \frac{\epsilon_1 + \epsilon_4}{1-\mu} + \frac{1}{1+\mu} \right]$
		$\sqrt{(\epsilon_1 - \epsilon_3)^2 + [2\epsilon_2 - (\epsilon_1 + \epsilon_3)]^2}$	$\sqrt{\left[ \left( \epsilon_1 - \frac{\epsilon_1 + \epsilon_2 + \epsilon_3}{3} \right)^2 + \left( \frac{\epsilon_2 - \epsilon_3}{\sqrt{3}} \right)^2 \right]}$	$\sqrt{(\epsilon_1 - \epsilon_4)^2 + \frac{4}{3} (\epsilon_2 - \epsilon_3)^2}$
Minimum normal stress, $\sigma_{min}$	$\frac{E}{1-\mu^2} (\epsilon_2 + \mu \epsilon_1)$	$\frac{E}{2} \left\{ \frac{\epsilon_1 + \epsilon_3}{1-\mu} - \frac{1}{1+\mu} \right\}$	$E \left[ \frac{\epsilon_1 + \epsilon_2 + \epsilon_3}{3(1-\mu)} - \frac{1}{1+\mu} \right]$	$\frac{E \epsilon_1 + \epsilon_4}{2(1-\mu)} - \frac{1}{1+\mu}$
		$\sqrt{(\epsilon_1 - \epsilon_3)^2 + [2\epsilon_2 - (\epsilon_1 + \epsilon_3)]^2}$	$\sqrt{\left[ \left( \epsilon_1 - \frac{\epsilon_1 + \epsilon_2 + \epsilon_3}{3} \right)^2 + \left( \frac{\epsilon_2 - \epsilon_3}{\sqrt{3}} \right)^2 \right]}$	$\sqrt{(\epsilon_1 - \epsilon_4)^2 + \frac{4}{3} (\epsilon_2 - \epsilon_3)^2}$
Maximum shearing stress, $\tau_{max}$	$\frac{E}{2(1+\mu)} (\epsilon_1 - \epsilon_2)$	$\frac{E}{2(1+\mu)}$	$\frac{E}{(1+\mu)}$	$\frac{E}{2(1+\mu)}$
		$\frac{1}{2} \tan^{-1} \left[ \frac{2\epsilon_2 - (\epsilon_1 + \epsilon_3)}{\epsilon_1 - \epsilon_3} \right]$	$\frac{1}{2} \tan^{-1} \left[ \frac{\frac{1}{\sqrt{3}} (\epsilon_2 - \epsilon_3)}{\epsilon_1 - \frac{\epsilon_1 + \epsilon_2 + \epsilon_3}{3}} \right]$	$\frac{1}{2} \tan^{-1} \frac{2(\epsilon_2 - \epsilon_3)}{\sqrt{3} (\epsilon_1 - \epsilon_4)}$
Angle from gage one axis to maximum normal stress axis, $\phi$				

<sup>4</sup> Perry, C.C., and Lissner, H.R., *Strain Gage Primer*, Second Edition, 1962, McGraw-Hill Co., p. 147.

TABLE X1.4 Data Obtained Using a Two-Element Strain Gage Located at Center of Glass

	Gage No.	Zero or Reference Reading, $\mu\text{in./in.}$ (a)	Microstrain Reading at 120 $\text{lb/ft}^2$ (5748 Pa) (b)	Measured Strain (b - a), $\mu\text{in.}$ (in.) <sup>A</sup>
First test	1 ( $\epsilon_1$ )	11 865	12 136	+271
	2 ( $\epsilon_2$ )	11 388	10 580	-808
Second test	1 ( $\epsilon_1$ )	11 865	12 114	+249
	2 ( $\epsilon_2$ )	11 388	10 606	-782
Average of tests	1 ( $\epsilon_1$ )	11 865	12 125	+260
	2 ( $\epsilon_2$ )	11 388	10 593	-795

<sup>A</sup> Positive values indicate tension; negative values indicate compression. 1  $\mu\text{in./in.} = 1 \times 10^{-6} \text{ in./in.}$  (microstrain).

## REFERENCES

- (1) Brown, W. G., “A Load Duration Theory for Glass Design,” *Proceedings, Annual Meeting of the International Commission on Glass*, held in Toronto, September, 1969, pp. 75–79.
- (2) Charles, R.J., “Static Fatigue of Glass I,” *Journal of Applied Physics*, Vol 29, No. 11, 1958, pp. 1549–1553.
- (3) Charles, R.J., “Static Fatigue of Glass II,” *Journal of Applied Physics*, Vol 29, No. 11, 1958, pp. 1554–1560.
- (4) Beason, W.L., “A Failure Prediction Model for Window Glass,” Institute for Disaster Research, Texas Technical University, Lubbock, May 1980 (NTIS Association No. PB81-148421), 212 pp.

*ASTM International takes no position respecting the validity of any patent rights asserted in connection with any item mentioned in this standard. Users of this standard are expressly advised that determination of the validity of any such patent rights, and the risk of infringement of such rights, are entirely their own responsibility.*

*This standard is subject to revision at any time by the responsible technical committee and must be reviewed every five years and if not revised, either reapproved or withdrawn. Your comments are invited either for revision of this standard or for additional standards and should be addressed to ASTM International Headquarters. Your comments will receive careful consideration at a meeting of the responsible technical committee, which you may attend. If you feel that your comments have not received a fair hearing you should make your views known to the ASTM Committee on Standards, at the address shown below.*

*This standard is copyrighted by ASTM International, 100 Barr Harbor Drive, PO Box C700, West Conshohocken, PA 19428-2959, United States. Individual reprints (single or multiple copies) of this standard may be obtained by contacting ASTM at the above address or at 610-832-9585 (phone), 610-832-9555 (fax), or service@astm.org (e-mail); or through the ASTM website (www.astm.org). Permission rights to photocopy the standard may also be secured from the Copyright Clearance Center, 222 Rosewood Drive, Danvers, MA 01923, Tel: (978) 646-2600; <http://www.copyright.com/>*